

ZDPM 25/25

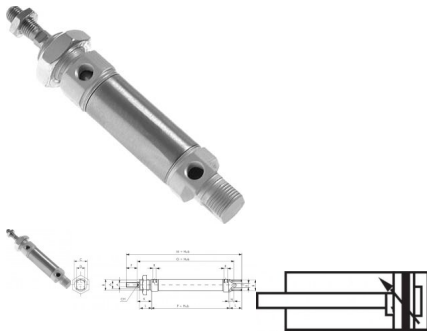

ISO 6432 cylinder, dubbelverkande, kolv Ø 25 mm, slag 25mm. Magnetkolv. Justerbar ändlägesdämpning.

Betyg: Inte betygsatt ännu

Pris

Pris 912,68 kr

Pris utan moms 730,14 kr

Rabatt

Momsbelopp 182,54 kr

[Ställ en fråga om denna produkt](#)

Beskrivning

Technical data

Piston Ø [mm] Piston Ø 25 mm

Stroke [mm] 25

Equipment adjustable end position damping, magnetic piston

A M 10 x 1.25

A1 [mm] 10

B M 22 x 1.5

C [mm] 30

D [mm] 16

E [mm] 8

F [mm] 22

G [mm] 104

K [mm] 28

L [mm] 22

M [mm] 140

N [mm] 12

P [mm] 68

R G 1/8"

CH [mm] 9

Weight 250 g / pc.